

Item No.	Qty	Description
14	70	Washers - 9/16" Cupped
15	78	3/8" Nuts
19	6	Support Tube
20	12	Carriage Bolts 3/8"x2-1/4"

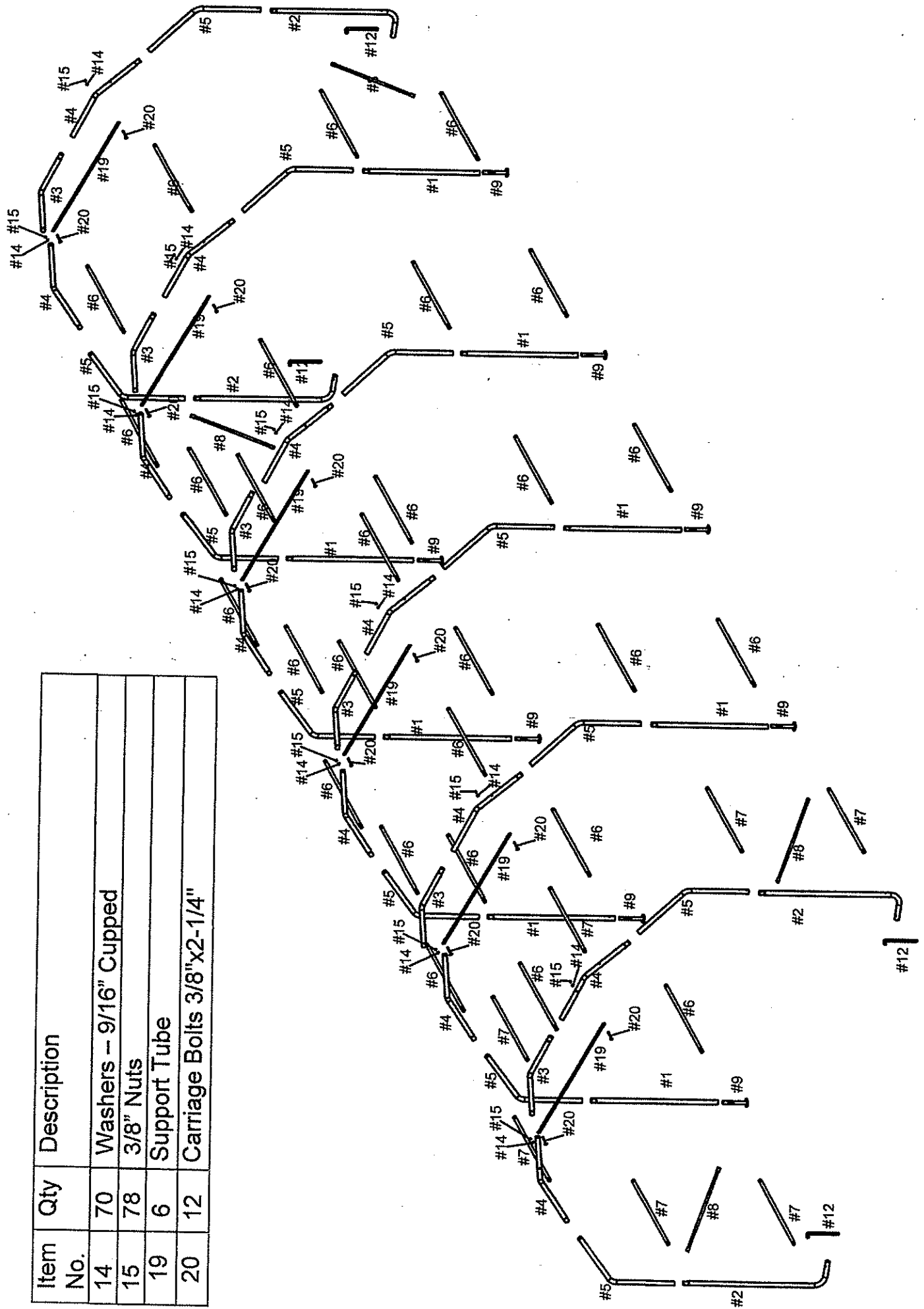



Assembly Instructions Barn Style 12 x 20 x 10

ASSEMBLY INSTRUCTIONS BARN STYLE 12Wx20Lx10H

Congratulations!

Congratulations on your purchase of a Barn Style Portable Building by MDM Products LLC. With proper installation, use, and maintenance, your new unit will provide many years of good and suitable service. Your new Rhino Shelter portable enclosure is a combination of excellent engineering and well thought out design. The unit is comprised of a rigid tubular frame, covered with a long life polyethylene cover and double door ends.

The multiple part frame assembly is pre-drilled for easy insertion of hardware to assemble. The tubing is made from high-grade galvanized steel tubing, to resist moisture and oxidation over the life of the shelter. The covering membrane is made from ASTM-5 approved polyethylene materials. The cover is also UV protected for continual exposure to the sunlight.

It is suggested that you read the assembly instructions completely before you begin. This will help attain the best results for your installation.

SAFETY WARNING

The installation of this unit must conform to the requirements of all authorities having jurisdiction in your specific local area. In the absence of such requirements, the installation must conform to the provided assembly and installation instructions. MDM Products LLC will not be responsible for failure to comply with any requirements in a given local area. Consequential damages or injuries caused by improper installation, alteration, or improper use are strictly that of the user. Unit **MUST** be cleared of All Snow Accumulation immediately to avoid overload. Unit is not to be used for occupancy for any length of time. No running internal combustion engines, open flames, or contact with heated surfaces are allowed.

For installation assistance or Customer Service, please call 800-447-7079 or 203-877-7070, 8AM-5PM EST. Cartons should be inspected upon delivery from carrier, and any evident damages should be noted on the bill of lading before signing. If upon opening the cartons hidden damage is noted, contact carrier or its agent immediately. Claims for shipping damage **MUST** be made with the shipping company. An inspection of the goods will most likely be required. Do not discard packing or any components before the freight company's inspection. All claims for freight damage must be made

with 15 days of receipt of the goods in accordance with ICC regulations.

ASSEMBLY PROCEDURE

The proper sequence and steps to install this unit will produce a proper and good installation. Failure to read and follow these guidelines may result in an improper installation and will void all warranty and protection the owner is entitled to with the product. The steps to be undertaken are:

1. Perform an inventory check before beginning to be certain all components are available for installation.
2. Prepare location and place unit boxes near location sight.
3. Assemble six (6) arch assemblies of unit
4. Assemble first unit End Arch, first Interior Arch, and Wind Braces with first Base Cross Rails and Side Cross Rail sections.
5. Add additional Arch Assemblies with each section of Base Rails, Side rails, and Top Ridge Rails.
6. Place frame into desired position and **level** frame both end-to-end and side-to-side. Set Corners. Measure frame feet across and square as needed.
7. Anchor frame assembly to ground with provided Anchors, u-bolts and drive rod provided.
8. Install two (2) Doors on both ends of frame assembly.
9. Install Main Cover over frame assembly.
10. Install Roll Up Door Kit to End Door.

TOOLS REQUIRED

The following hand tools are suggested for proper installation of your new Rhino Shelter unit:

- 9/16" Open End Wrench
- 9/16" Socket or Box Wrench
- Large Flat Tip Screwdriver
- Maul or Sledgehammer
- 2-foot Level
- 10-Foot Step Ladder

INVENTORY CHECK

Start installation procedure by removing all components from packaging and ensure all components are present

Item No.	Qty	Description
1	8	Interior Arch Straight Uprights Fem x Male 2-3/8" Diameter
2	4	End Arch Uprights with Foot 2-3/8" Dia.
3	6	Ridge Bend - Male x Male 2-3/8" Dia.
4	12	Ridge Bend - Male X Female 2-3/8" Dia.
5	12	Ridge Bend - Female x Female - 2-3/8"

V1.2

Do NOT Return Assembly To Dealer or Store. For All Assembly Questions or Shortages Please Call MDM Products Directly
Customer Service 800-447-7079 or 203-877-7070



Assembly Instructions Barn Style 12 x 20 x 10

		Dia.
6	28	Cross Rails – Male X Female 1 1/8" Diameter
7	7	Cross Rails - Female x Female 1 1/8" Dia.
8	4	Wind Braces – Flattened Ends 1 1/8" Dia.
9	8	Steel Foot with Base Plate
10	42	3/8" Carriage Bolts – 4" length
11	24	3/8" Carriage Bolts – 3" Length
12	4	3/8" Round Metal Ground Peg
13	8	Washers 9/16" Flat – Wind Braces
14	58	Washers – 9/16" Cupped
15	66	3/8" Nuts
16	4	3/16" Rope
17	1	Main Barn Cover
18	2	Doors Ends – Barn Style
	12	Earth Cable Anchors
	12	U Bolts with Nuts – 2 1/2"
	1	36" Drive Rod
	2	3/16" Rope
	4	2-3/8" Plastic End Plugs
	16	1" Plastic End Plugs
	1	Roll Up Door Kit w/ Hardware

Note: All Side and Base Cross Rails MUST be located on the Inside of Arch Frame Members. Top Ridge Cross Rails MUST be on Outside of Arch Frame members, except at Ends. See Frame Assembly Step 5.



Assembly Instructions Barn Style 12 x 20 x 10

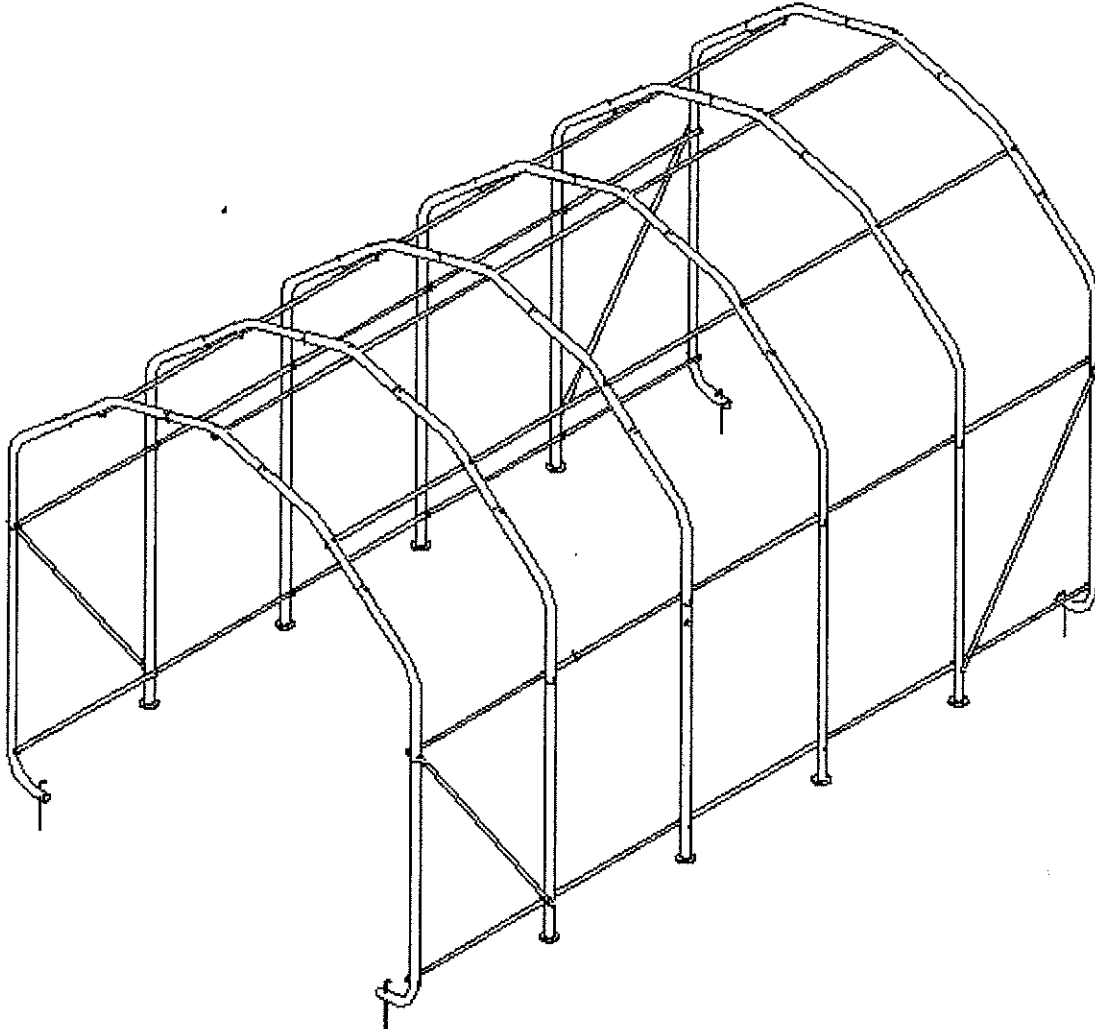

Barn Frame Assembly 12 x 20 x 10

SITE PREPARATION

Select a level or as close to level as practical location for your Rhino Shelter unit. The unit should be placed on a base of materials suitable for the storage load to be protected. A bed of crushed process rock will make an ideal base. The unit should not be located under trees, which will shed hard fruit such as apples, walnuts, or heavy pine cones. The cover of your unit will protect against normally leaves and light debris, however large branches or other falling items may cause puncture or tears in the cover material.

Take notice of drainage both near and around your intended location. Water draining from the surrounding terrain should be planned so that it does not run into the unit. As well, rain or melting snow that comes off the unit should be drained away rather than accumulate and pool around the unit.

V1.2

Check to be certain that adequate clearance is allowed for entry and exit from ends of unit. As unit has doors on both ends, ideally vehicle or contents can be inserted or removed from either end.

FRAME ARCH ASSEMBLY

Step1. Assemble the (2) Front and Rear End Arches using (1) #3 Ridge Bend MxM, (2) #4 Ridge Bend MxF, (2) #5 Ridge Bend FxF, and (2) #2 End Upright with Foot for each arch. Use (4) 4" carriage bolts with nuts and cupped washers through pre-drilled holes in frame members.

Be certain to insert carriage bolts from the outer edge into the interior of the unit, with the washers and nuts on the inside of the arches. This will avoid tearing the fabric on doors and main cover when installed. Do not tighten



Assembly Instructions Barn Style 12 x 20 x 10

the nuts completely until the frame is completed and set in place.

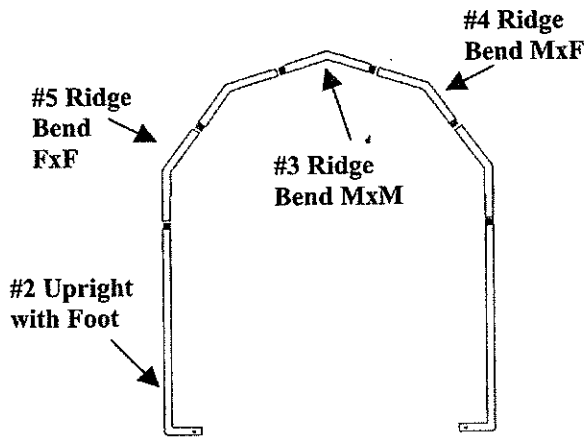

Step 2. Assemble the (2) Corner Wind Braces #8 to #2 End Upright w/Foot to the first of the End Arch assemblies. Use a #11 3" Bolt with Washer and Nut to secure the braces loosely to the Upright. Do not tighten completely.

Step 3. Assemble the remaining four interior arches using (1) #3 Ridge Bend MxM, (2) #4 Ridge Bend MxF, (2) #5 Ridge Bend FxF, (2) #4 Straight Upright, and (2) #9 Steel Foot with Plate for each of the arches. Use 4" carriage bolts with washers and nuts in the pre-drilled holes, aligned to form the arch.

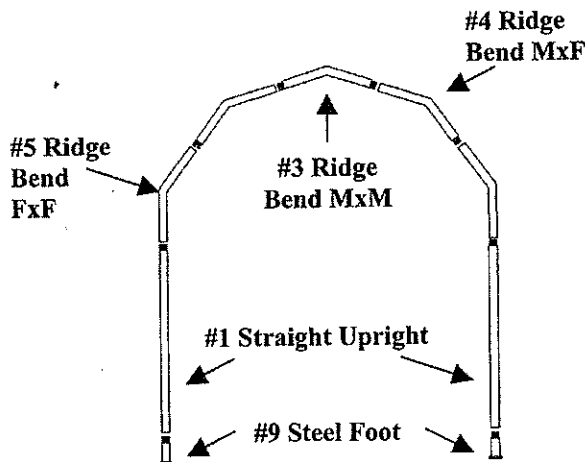

COMBINE END ARCH & INTERIOR ARCH

Support the End Arch with Wind Braces temporarily in the vertical position. Connect (4) #7 Plain End FxF Cross Rails to the first End Arch with (4) 3" Carriage bolts, washers, and nuts through the pre-drilled holes in the arch members. The Swedged end of the Cross Rails should face the interior of the unit to accept the next cross rail. The Cross Rails should be put into the bottom

V1.2

and side hole of the arch upright. Again, don't tighten the hardware until the next arch and cross rails are assembled. It is very important to make certain all nuts are on the inside of the unit to avoid damaging the cover when put on.

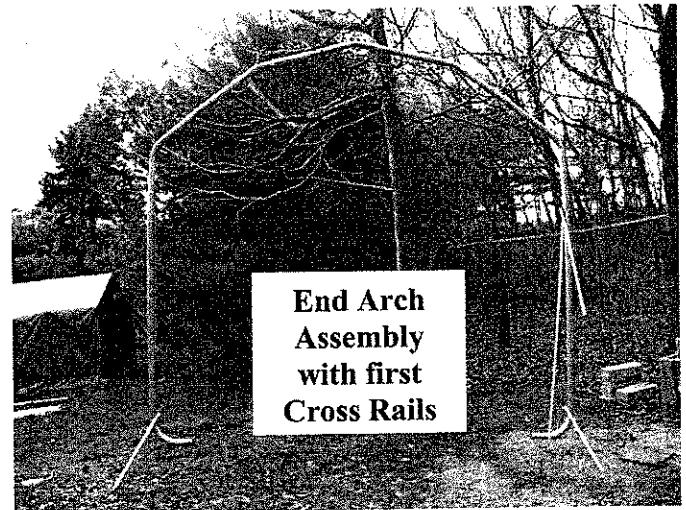

Stand the first End Arch Assembly and the first Interior Arch Assembly up vertically into position. The base and side cross rail end holes align with the holes in the interior arch to make the first connections. Using (4) with nuts and washers, connect the cross rails between the end arch and the first interior arch assemblies. The two Arches must be supported upright until the Wind Braces are put into place or the frame will fall. Connect the (2) #8 Wind Braces diagonally across the end and interior arch as shown in the frame illustration. Once the Wind Brace are installed the frame will be self-supporting.

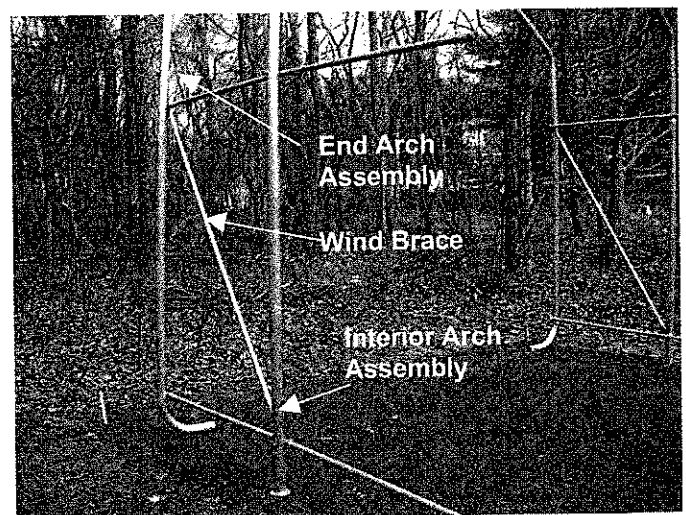

Begin the Top Ridge Cross Rail by placing a #7 Cross Rail FxF underneath the End Arch Top Crest Tube.



Assembly Instructions Barn Style 12 x 20 x 10

Secure the Cross Rail loosely with a 3" Carriage Bolt with washer and nut facing the interior of the unit. Male End of next Cross Rail fits into Female end of cross rail. Cross Rails are built by placing rails into each other on the same carriage bolt.

Add #6 Cross Rails MxF to base, side and top ridge before adding the next Interior Arch. The carriage bolts on the arch assemblies also go through the common hole on each rail assembly.

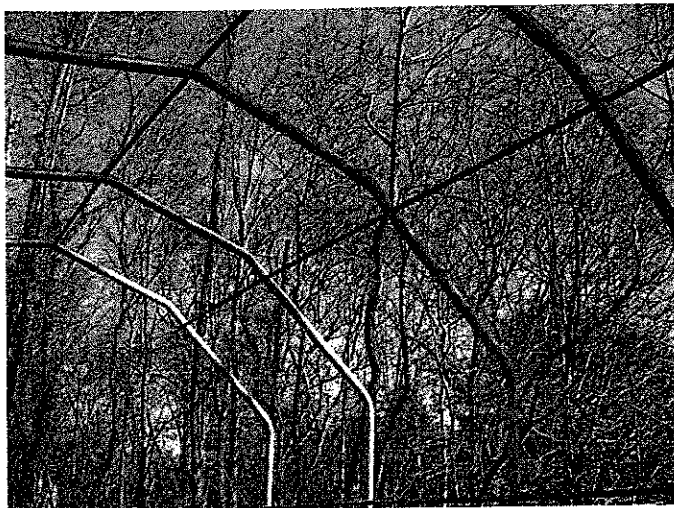

Side & Top Cross Rails between Arch Assemblies

Step 5 – Add Remaining Arches To Frame

Add remaining 3 interior arches and rear end arch in the same fashion. Note that the Swedged Cross Rails #6 should fasten under the Top Ridge Bend of the final End Arch and above the Top Ridge Bend of the interior arches.

NOTE: Do not completely tighten bolts that connect the Cross Rails to the End Arches. They must be removed for proper End Panel Zippered Door installation

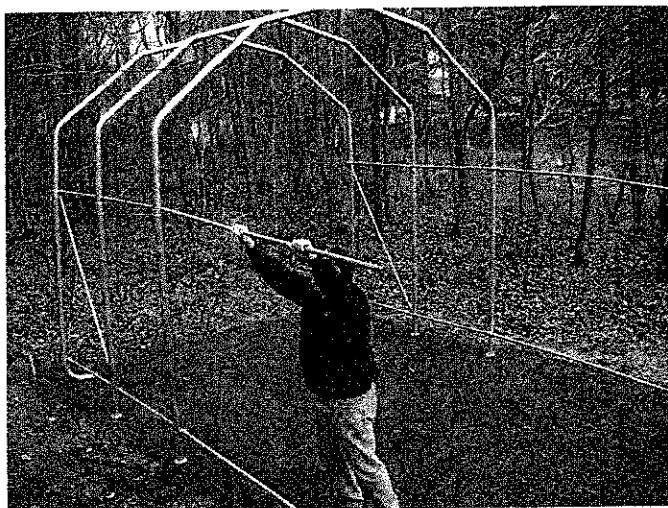

Add Cross Rails in preparation for adding Arch Assemblies



SQUARE & LEVEL FRAME

Adjust the frame assembly in its final installation location. This should be done with more than one person lifting each side or corner to avoid bending or stressing any frame members. Frame must now be squared up in position.

Align one end corner in the final position desired. Use a line strung from front to back to align all arch members on that side from end to end. Each corner of the Barn style has a hole vertically through the foot base. Put the end arch exactly where desired, and insert #12 Round 3/8" Metal Peg into ground to prevent leg base from moving. Install the Leg Peg into the other end corner foot base. Re-check the position of all interior arch uprights for alignment.



Assembly Instructions Barn Style 12 x 20 x 10

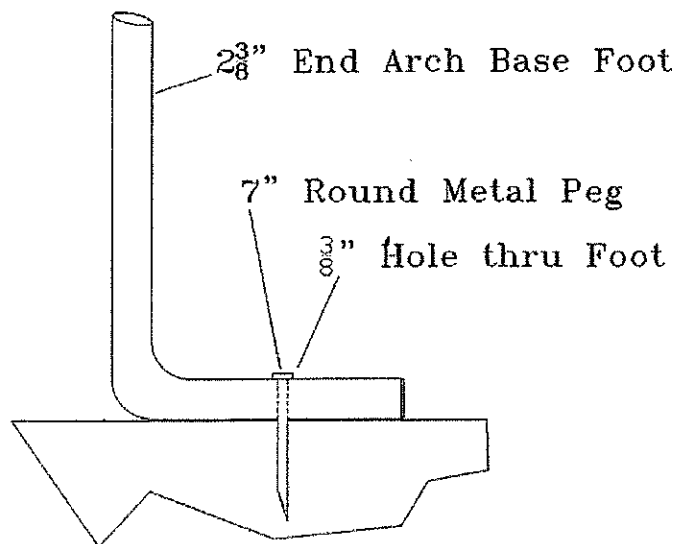

Measure frame width across from outside to outside of frame members. Adjust to 12' width along entire frame length.

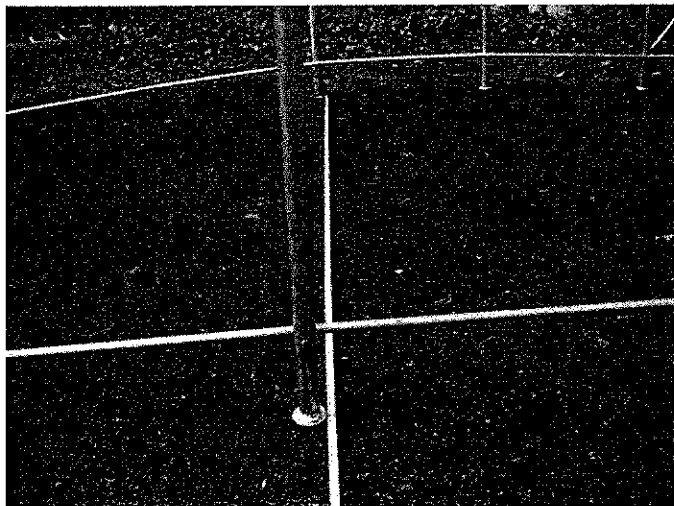

When all widths are adjusted properly, measure from diagonally from inside corner to inside corner. Adjust frame as necessary to bring frame into square. **Failure to square frame of unit will result in poor cover fit and reduced strength and rigidity.** If end or interior upright ends are placed on soft material that will not support weight, recess small patio blocks or bricks under leg ends. This will also allow better setting of frame before securing to ground.

The Rhino Shelter Barn style unit features Adjustable Base Legs on all interior arch bottoms. By removing the carriage bolt through the frame members, you can adjust the interior arch ends up or down so that they sit square

on the ground. Adjust each leg before securing to ground so that bottom cross rails are level.

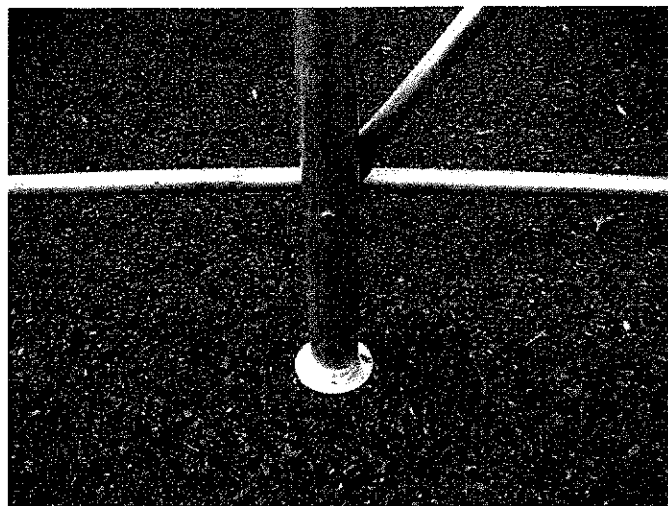

ANCHORING FRAME TO GROUND

Once frame is square and properly supported, tighten carriage bolts on all frame members, except for End Arch members to Cross Rails along base, side, and top. Do not over tighten or oval tubing. After hardware is tightened, insert plastic end plugs #14 (2 3/8") & #15 (1 1/8") into all open ends of frame members.

NOTE: Frame must be anchored before installing any doors or cover.

Each Rhino Shelter 12x20x10 building comes with 14 EARTH CABLE ANCHORS with U-bolts and nuts. These versatile anchors allow the frame to be secured to almost any surface. In addition you have also been provided with a 36" Drive Rod used to drive the anchor heads into the earth.

If the location where you are placing the building has very hard ground or any rock in it, pre-drill the holes before inserting anchors. Hammer drills can be rented at most home improvement or rent-all centers. Hitting the anchors into rock will cause the drive rod end to mushroom inside the anchor head, and prevent the drive rod from coming out of the hole.

Anchor placement should be made inside the frame at the interior corners of the unit, and midway along the sides of the frames. Anchors secure the building to the ground, as well as prevent spread of the frame over time.

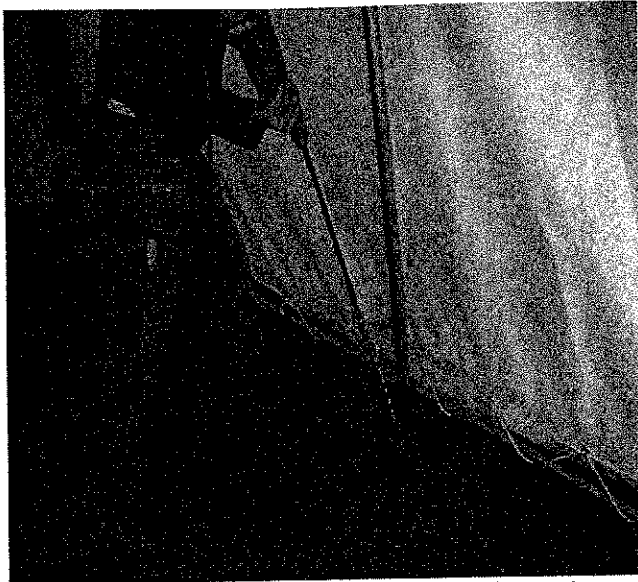

Pre-Drill Holes if there is Any Rock In Ground

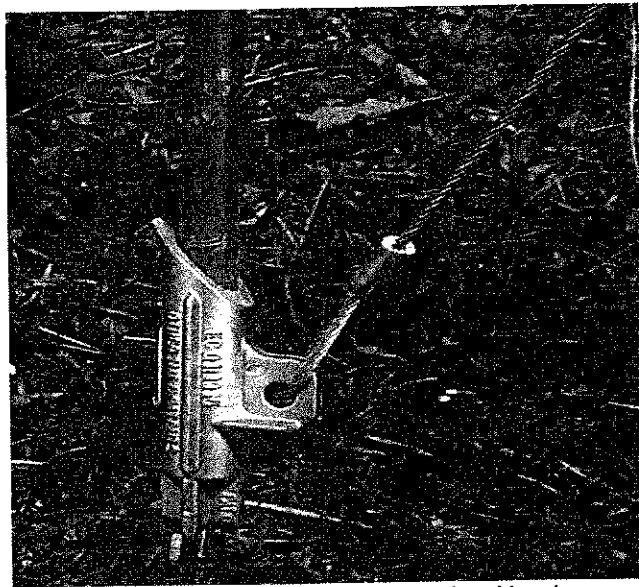

Drive Rod inserts into Anchor Head

ANCHOR STEP 1

Step 1. Place the drive rod provided into the cup of the anchor. Using a heavy hammer drive the anchor into the soil until 6-8 inches of cable remains above the earth. Remove drive rod.

ANCHOR STEP 2

Place the Drive Rod through the loop in the anchor lanyard. Pull upward to set anchor head into the ground.



ANCHOR STEP 3

Slip one side of the U-bolt through the eyelet at the end of the anchor cable. Attach the cable to the Arch leg upright with the U-bolt and tighten. Do not attach to base cross rails. Ensure there is no slack in the cable. Slack can be removed by wrapping the cable around the tie-down rail.

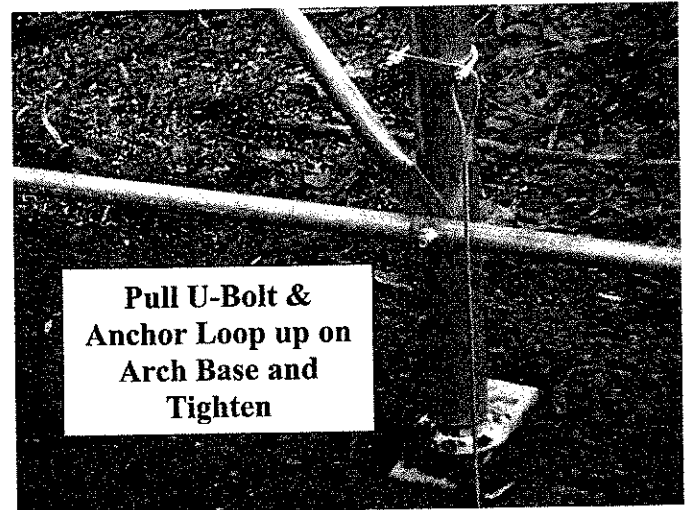

END PANEL INSTALLATION

Note: Both End Panels MUST be installed before installing Main Cover onto frame.

Step1. Remove Carriage bolts from the Top Crest Rail and the two Upper Cross Rails. Install one #14 End Panel Door w/Zipper at a time to the Frame assembly.

Step 2. Place the end panel over the first arch and wrap the material around the arch bringing the slits in the end



Assembly Instructions Barn Style 12 x 20 x 10

panel to the inside of the frame arch. End Door Panels have pre-cut slits that allow frame members to pass through so rope pocket is inside unit. Place the top ridge pole and the side cross rails through the material slits and replace the carriage bolts and tighten. The door end will also require removal of the wind brace bolts and placement of the wind braces through slits in the ends panel. Reconnect wind braces with carriage bolts once end panel is put into place.

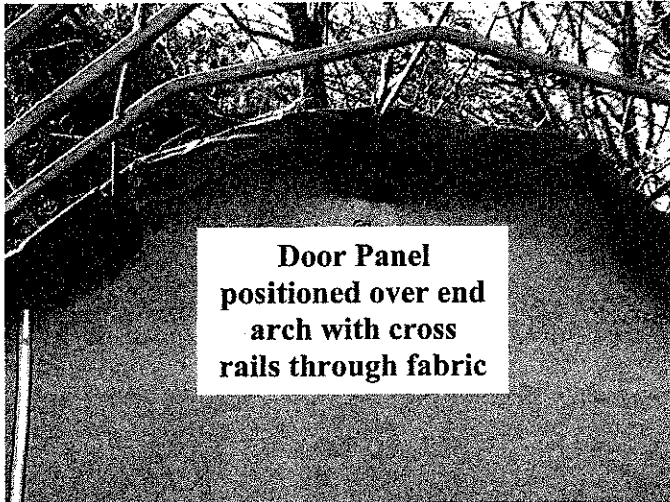

The rope channels should be located inside the unit, with the frame members passing through the pre-cut slots in the end panel/door. Replace and tighten the carriage bolts after putting the end panel into position.

Door assembly is drawn taut over end frame by tightening rope and securing to turnbuckles at the arch foot. Frame must be secured in position so it does not move as end doors and main cover are tightened over frame. This step is key to good fit and to prevent door movement in wind.

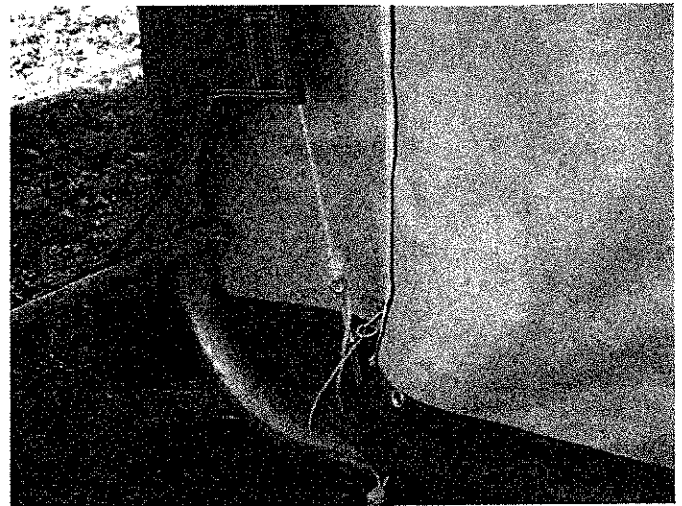

Door Turnbuckle Attached to Base Foot

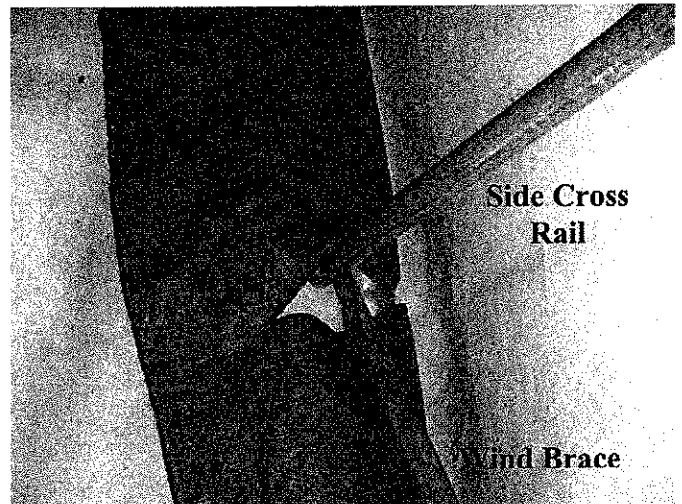

Side Cross Rail

Wind Brace

When putting on the doors, adjust the length to make certain the doors do not drape onto the ground. Adjust door length by pulling more or less fabric over end arch. If pulling them up puts too much stress on the slit where it goes over the wind brace, use a sharp knife to cut slit another inch or two to relieve it. The PE fabric is rip-stop weave, and can easily be cut to relieve stress at the frame members.



Assembly Instructions Barn Style 12 x 20 x 10

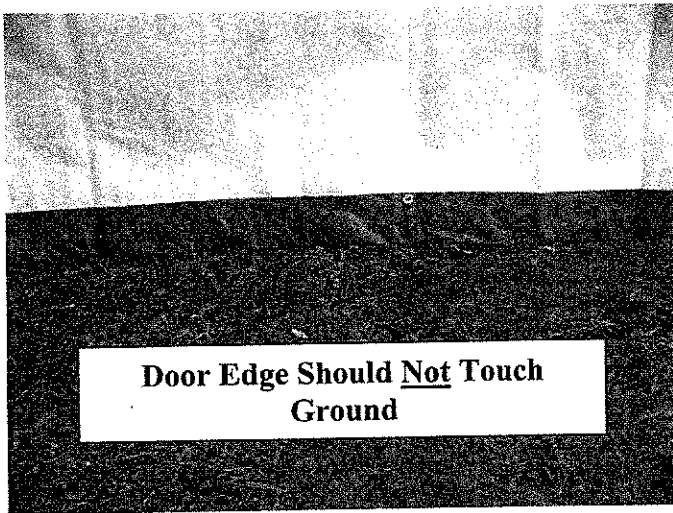

Step 3. Tie off one end of the rope coming out of the end panel to a turnbuckle. Turnbuckle should be loosened all the way and the open hook end attached to the hole in the inside of the end arch. Hold the end of the unsecured rope and apply pressure downward with a foot to remove excess. Re-adjust gathered material evenly along door rope. This step is key to getting a good door fit. Tie off the end of the rope to a second turnbuckle attached to a hole in the foot of the end arch on the opposite side. The end panel can be adjusted further by tightening the turnbuckles.

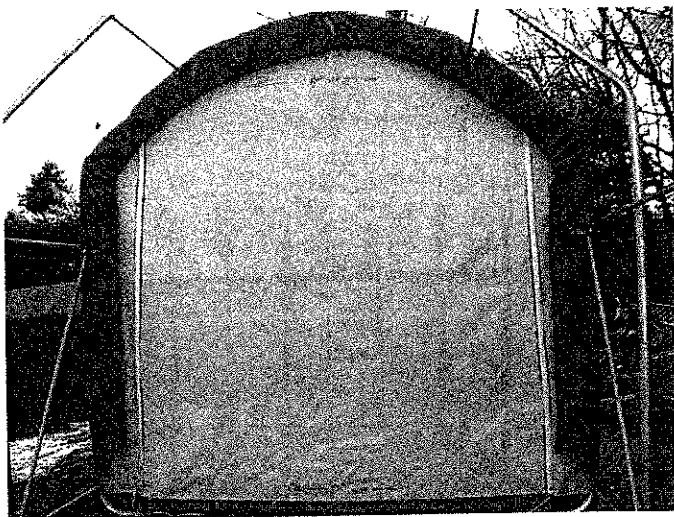

Note: After door panel is installed with all slack out of rope, adjust/snug the end panel by turning the turnbuckles or repeating step 3 on a regular basis

MAIN COVER INSTALLATION

Step 1. To elongate the life of Main Cover, put a small square of duct tape (field supplied) over each bolt head on frame that comes in contact with cover. The tape

V1.2

acts as a cushion to avoid rubbing damage to the cover over years.

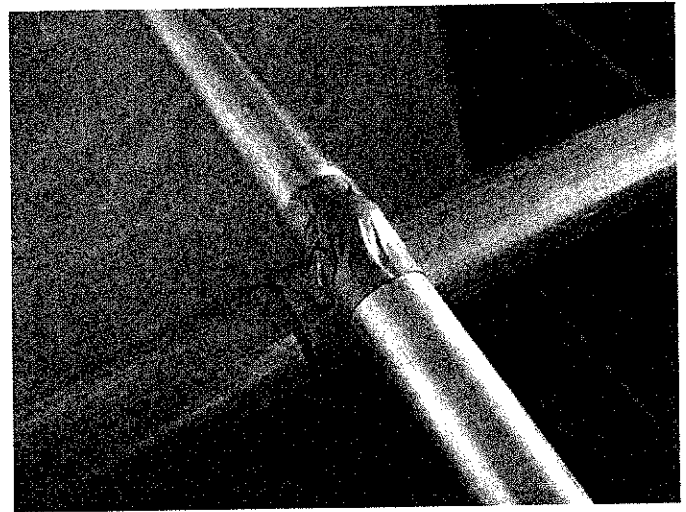

Unpack the Main Cover from the protective plastic packaging. The line of grommets on the inside (white) of the cover on the tie down Flap run parallel to the sides of the frame assembly for positioning. Once cover is oriented properly to the Frame Assembly, pull Main Cover over frame assembly from the side, being careful not to snag the cover on any member, bolt, or other obstruction. Center the Main Cover over the Frame Assembly with the Main Cover colored side showing from the outside of the unit.

Step 2. Loosen the 4 ratchets. Place the hook that is attached to the ratchet strap into the outer hole in the foot of each end arch.

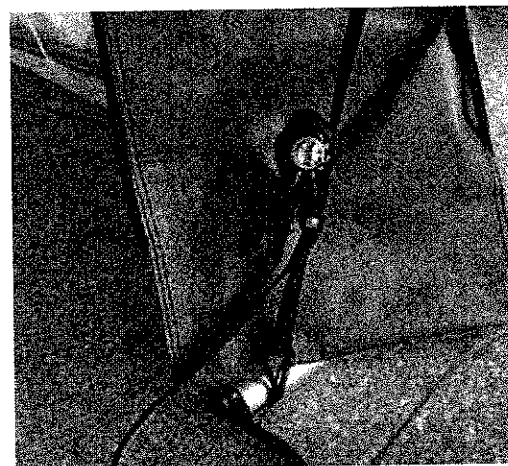

Step 3. It is important that your cover is laying square over the frame before you start ratcheting down the cover. Once the cover is even on all four sides, slowly start ratcheting down all four corners.



Assembly Instructions Barn Style 12 x 20 x 10

Warning: Do not over tighten the ratchet straps.

Pay close attention to how tight the cover is put onto the frame. It should be tight enough so it does not flap around in the wind, but not so tight that it tears the material cover. The fabric backed PE fabric of Rhino Shelter units does not stretch. If you pull it so tight that the fabric is stretched, a small amount of additional stress from wind or contact can cause premature tears and material failure. Only tighten cover enough to remove valleys between arch assemblies. Do Not over tighten.

Once the ratchet starts becoming harder to tighten stop so you do not damage the cover.



Step 4. When the cover is completely aligned secure the cover to the bottom tie-down cross rail using the rope provided. Start at one end and tie off the rope to the cross rail. Lace the rope through the grommets in the cover and back under the tie-down cross rail. Repeat this on the opposite side.

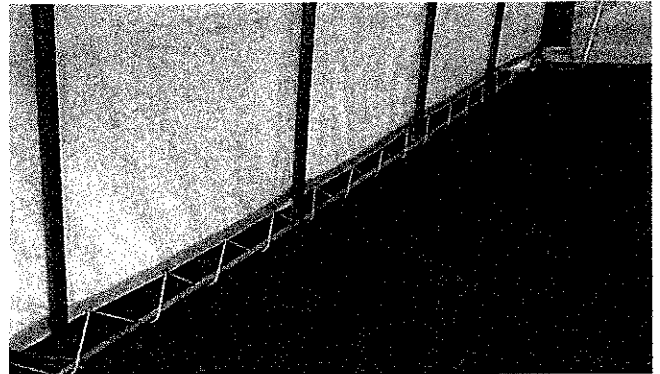

Lace rope through grommets and around Base Cross Rails

ROLL UP DOOR KIT

A Roll Up Door Kit is included with Barn style buildings. Rhino Shelter doors are manufactured with a pocket on the bottom edge along the width axis. Combine the two pieces of 1 1/8" diameter tubing provided with the machine thread screw. Place one 1 1/8" plastic end plug into one end of the tube assembly. Fill the tube with sand or comparable weight material, and place the other plastic plug into the end of the tube. The additional weight will reduce door movement in wind, and assist it in rolling up. Place the weight tube into the bottom edge pocket in the door. Center the weighted tube between the edges of the door.

Tie the rope provided onto the end arch under the roll up door material over the end arch. Thread the rope under the door edge to the outside of the unit

Two rollers are provided, which must be mounted onto the door at the top outside edge. Cut a small 1/2" slit in the material so the rollers can be mounted over the rope in the door as shown in the illustration.

Cut the rope to the lengths needed. They will NOT be the same length; so do not cut the rope before putting through the rollers on top and pulling both to one side.



Assembly Instructions Barn Style 12 x 20 x 10

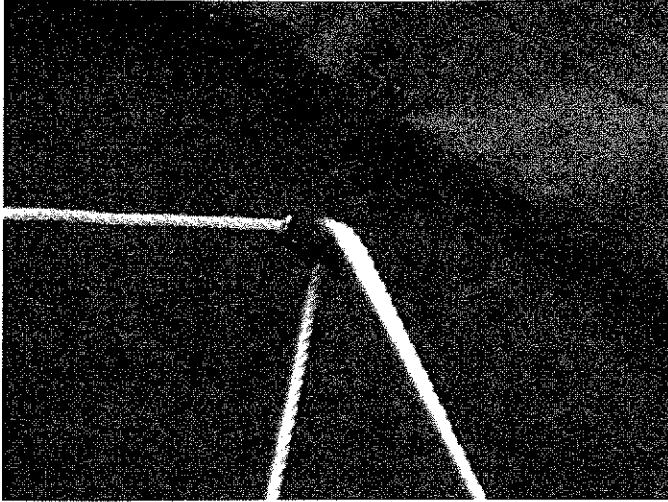

Roller installs on outside rope channel of door

Thread the rope through the rollers as shown in the picture below. The door can now be rolled up by pulling on both ropes to one side. A cleat tie off is provided as well. This can be mounted to the end arch frame between the door flaps, or through the cover on the outside of the unit to the end arch member.

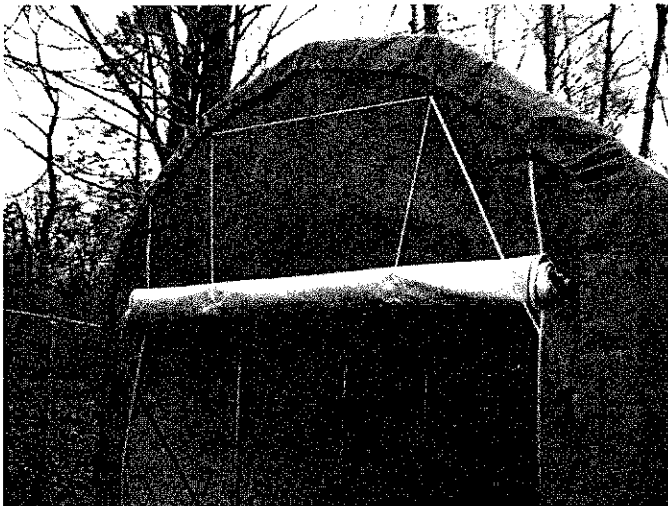

Roll Up Door Kit with Door partially opened

Three (3) straps are provided on each door side zipper to reduce the strain on the zipper when the wind blows. Roll the door up from the bottom with the ropes and secure the ropes to the tie off cleat.

MAINTENANCE AND CARE

Annually or more often, the unit should be completely inspected internally and externally to make certain the unit remains properly installed and secured. Particular attention should be paid to:

Hardware – check all carriage bolts and hardware connectors to be certain they are in place and tightened.

Anchors – during normal weather trends, the unit will strain against the anchors under windy conditions. Anchor hardware connection to frame members should be maintained tight and depth of anchors should be checked to be certain they remain deeply and firmly set.

Snow Accumulation – All snow accumulation on the main cover should be removed as soon as possible. The days that follow a snowfall, when snow melts, are when the most damage can occur. Unit is not designed for any amount of accumulated snow or ice. Warrantee does NOT cover snow accumulation damages. Unit is not designed for any significant amount of accumulated snow or ice. Tap the main cover from the inside with a broom end to knock off any accumulated snow.

Main Cover Lacing – the poly rope that secures the main cover to the bottom rail of the frame assembly should be checked, and adjusted as needed. The tension on the main cover should be uniform from end to end and side to side. Rope ends must be tied off onto the frame members at the ends on each side.

Turnbuckle Adjustment – during normal wind conditions and load, the doors and main cover adjustment points at the turnbuckle should be checked and tightened as necessary. The turnbuckles should be neither completely extended nor taken up, so that turnbuckle should be tight when in the mid range of overall adjustment. If necessary, readjust rope tie off on turnbuckle as needed to tighten or loosen as needed.

Cleaning – cover and doors can be cleaned with a mixture of light detergent and water. A soft bristle brush with the mixture can be used to loosen any hard dirt, mold, or buildup on the cover. After cleansing, the cover should be rinsed thoroughly to avoid any chemical reaction from residual detergent. Allowing dirt and debris to sit on cover over an extended time will damage cover irreparably.

Severe Weather – in preparation for inclement weather, completely secure the doors on both ends of your Rhino Shelter garage. Allowing wind to enter either end lifts the building and puts undue stress on the anchoring system. This also shortens the life of the doors, zippers, and main cover. Always keep retaining straps n outside of door ends made up when the door is closed. These straps will take stress off the door zippers and elongate their useful life.



Assembly Instructions Barn Style 12 x 20 x 10

CUSTOMER SERVICE & INSTALLATION PACKAGES

Please call MDM Products directly at 800-447-7079 or 203-877-7070 for questions about the installation of the unit in any way. Care and attention to a proper installation will add many years of life and function to your Rhino Shelter unit.

Please retain purchase documentation for your Rhino Shelter unit. All warranty claims must include purchase documentation for verification. All parts on your Rhino Shelter unit are available for replacement as needed. Protect your purchase by completing warranty registration card and mail/fax as soon as practical after installing your unit.

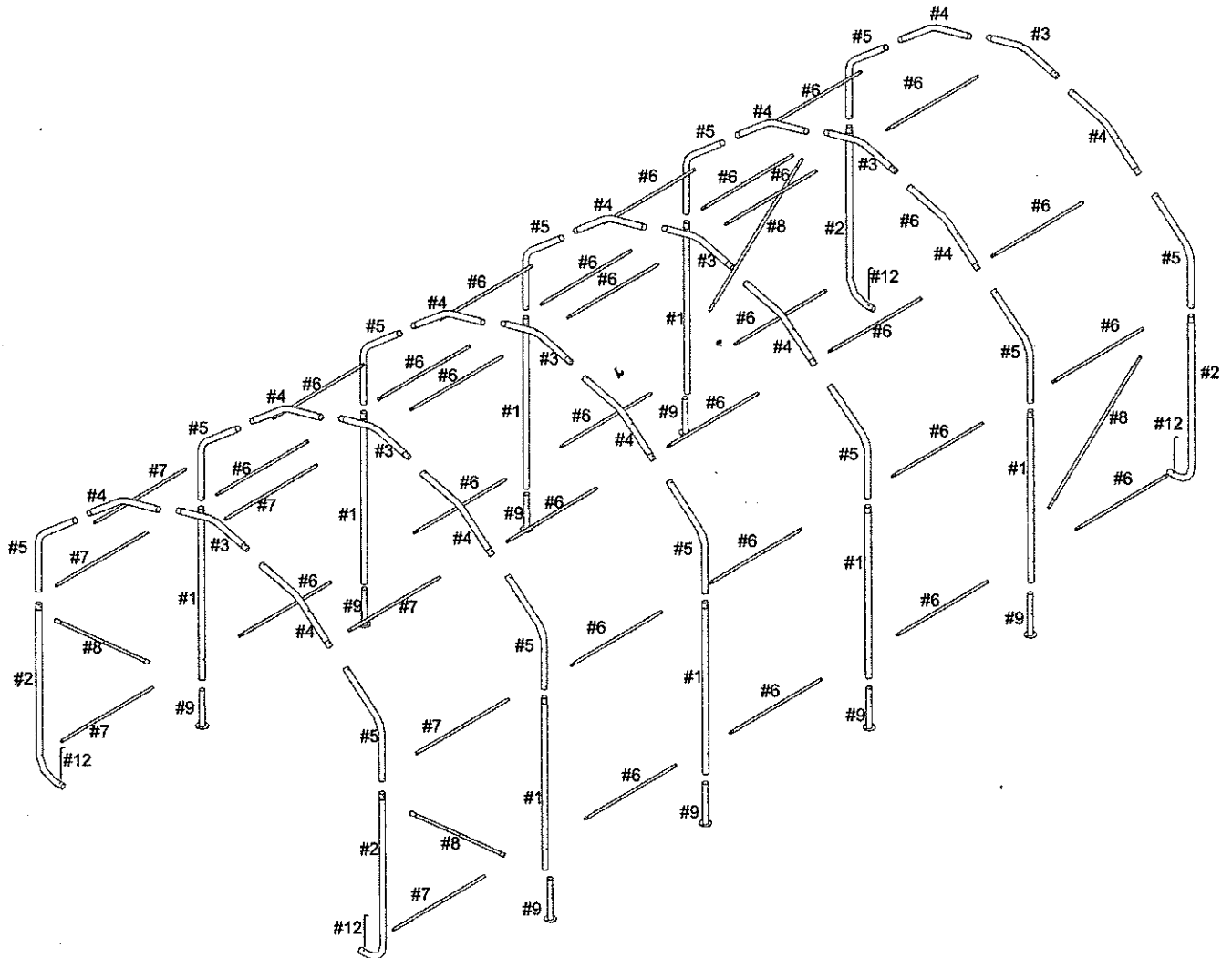

**Frame Illustration Identified by Part Numbers
12 x 20 x 10 Barn Style**